

Sento faro singolo low voltage halogen

Ceiling lamp - modular system consisting of body and head

Thanks to its unique modularity the Occhio head-body system delivers impressive lighting solutions for your room. For different lighting effects diverse, turnable reflector heads are available, which can be easily substituted at any time thanks to a simple plug-in mechanism. The diverse wall and ceiling boxes allow for all recessed and surface mounting options.

Ceiling lamp Occhio Sento faro singolo consisting of

- body Occhio faro singolo - different length and surfaces
- head Occhio Sento - different lighting effects and surfaces
- Occhio accessories - different mounting options and surfaces

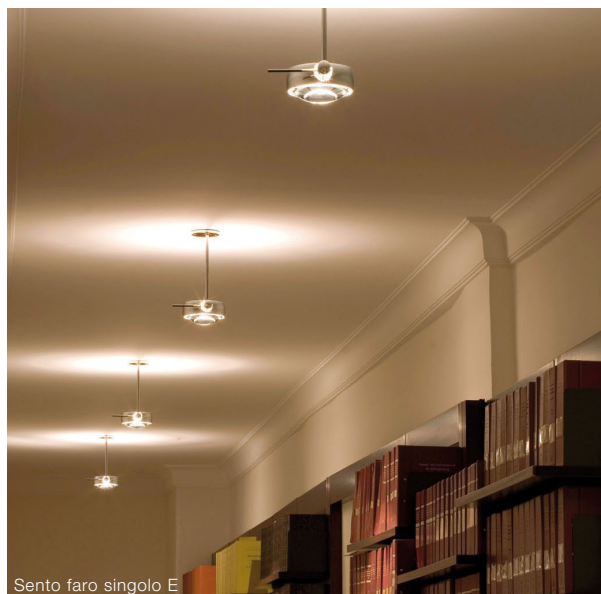
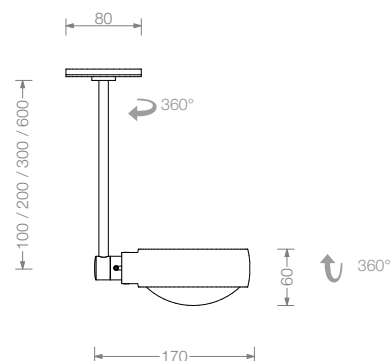

material

aluminium, brass, steel, glass

surface

head: see p.2 cutsheet
body: chrome, chrome matt

length / rotation angle

10 cm, 20 cm, 30 cm, 60 cm / 360°

recommended lighting effects

B, C, E see p.2 cutsheet

light source

low voltage halogen, QT 12, operating voltage 12 V
2 x max. 100 W, Gy6.35,
energy efficiency grade B, lifetime 4.000 h

luminous flux (bulb)

50 W / 1180 lm, 60 W / 1650 lm

color temperature / color rendering

3000 K / CRI 100

weight

body + head max. 1,5kg

mounting accessories

for surface or recessed mounting, see p.3 cutsheet

Sento faro singolo recommended lighting effects

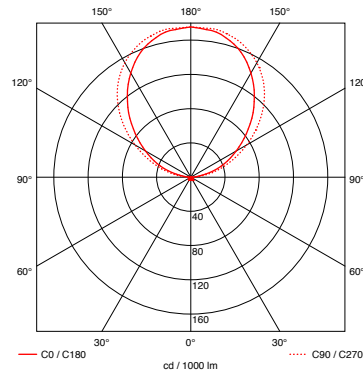
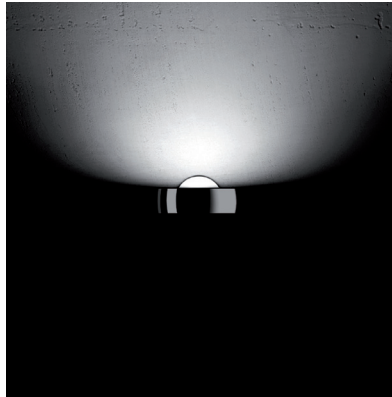

Sento B (glass matt / cover)
reflector head for diffuse light
in one direction

luminous efficiency
49%
glass
satinised, heat-resistant glass
ring / cover
chrome, chrome matt
white or black glossy finish
(bianco, nero)
holder
chrome, chrome matt

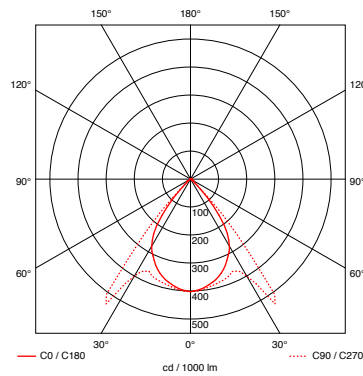

Sento C (cover / lense)
reflector head for directed light
in one direction

luminous efficiency
56%
beam angle
approx. 85°
lense
optical glass
ring und cover
chrome, chrome matt,
white or black glossy finish
(bianco, nero)
holder
chrome oder chrome matt

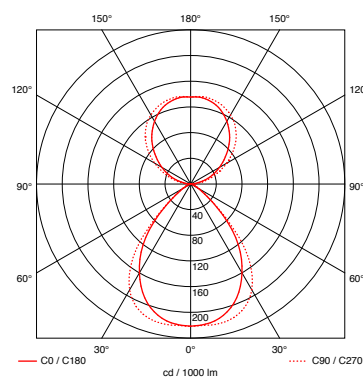

Sento E (glass matt / lense)
reflector head for diffuse light in one and
directed light in the other direction

luminous efficiency
83%
beam angle
approx. 85°
glass
satinised, heat-resistant glass
lense
optical glass
ring
chrome, chrome matt,
white or black glossy finish
(bianco, nero)
holder
chrome oder chrome matt

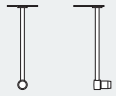

Sento faro singolo Item numbers

faro singolo		Item number
	max. 100W low voltage halogen, Gy6.35 turnable	10 cm
		20 cm
		30 cm
		60 cm
		_chrome matt M _chrome C
		7F 10 00 _ 7F 11 00 _ 7F 12 00 _ 7F 14 00 _

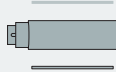
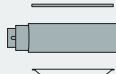
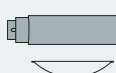

Sento B			
	glass matt / cover	chrome matt	8K 00 72 M
		chrome	8K 00 72 C
Sento C			
	cover / lens	chrome matt	7K 00 63 M
		chrome	7K 00 63 C
Sento E			
	glass matt / lens	chrome matt	7K 00 75 M
		chrome	7K 00 75 C
		bianco	7K 00 75 B
		nero	7K 00 75 N

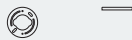

mounting transformer on site			
flat box			
	for plastering or wall / ceiling box h 8 mm, ø 80 mm		8Z 00 00 M
			8Z 00 00 C
Electronic transformer			
	for flush-mounting max. 105 W l 107 mm, w 52 mm, h 30 mm		7Z 00 01 T

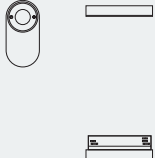

transformer in surface mounted box			
Box singolo			
	mounting version incl. electronic transformer 35 – 75 W 176 mm, w 88 mm, h 28 mm	matt chrome	7Z 40 10 M F
		chrome	7Z 40 10 C F
		bianco / chrome	7Z 40 10 B F
		nero / chrome	7Z 40 10 N F
	track version	matt chrome	4Z 40 10 M F
		chrome	4Z 40 10 C F
		bianco / chrome	4Z 40 10 B F
		nero / chrome	4Z 40 10 N F